

- | | |
|----------------------|-------------------------------|
| 1. BASE PLATE | 6. WIRING PLATE |
| 2. SELF PRIMING PUMP | 7. SOLID STATE RELAY (S.S.R.) |
| 3. S. S FITTING | 8. OUTLET |
| 4. FLOW METER | 9. 'T' FITTING |
| 5 METER COVER | 10. FLOW SENSOR CAP (ORANGE) |

PANERA --- THE BEST WAY TO USE.

I) Water:

- 1) Use clean water.
- 2) Suspended particles should not be more than 10000ppm]
- 3) Use special "VATS" make filter at the Inlet.
- 4) Use sealed plastic drum to store the water or pls. Supply the direct water line(i.e. Rigid piping) to the Inlet of the machine.

II) Fittings:

- 1) For rigid piping---Pls. follow the installation precautions (Pls. go through the instruction manual) or discuss with manufacturers
- 2) Proper fitting precautions/installation precaution must be taken when you are using Inlet mechanical valve,
- 3) Proper insertion or proper fitting of Hose piping must be done. It will avoid suction problem.

III) Electrical:

- 1) The AC supply voltage must be in the range of 200V to 250V, 1 Phase, 50 Hz.
- 2) Proper grounding/earthing is required.
- 3) Pls. take care so that water should not get enter in DP SWITCH, ELECTRONIC MODULE or TERMINAL STRIP.

IV) Batch Setting / Electronic Module Interface:

- 1) Pls. go through the instruction manual to get familiar with control keys & their functions.
- 2) Don't change the scale factor. It will change the water outlet quantity.
- 3) Use volumetric calibration method for calibration

V) Service Support:

"VATS" is committed to give service support after Sales.
Tel. No. Tel 91+20 + 25430897 / 25432157 / 25436180

Trouble Shooting

PROBLEM	POSSIBLE CAUSES	REMEDIES
<ul style="list-style-type: none"> Pump Failure. 	<ol style="list-style-type: none"> Pump does not start Clogged filter 	<ol style="list-style-type: none"> Check connections and voltage values. Clean filter
<ul style="list-style-type: none"> Pump runs without pumping water 	<ol style="list-style-type: none"> Suction hose loose or broken. Non Return Valve (NRV) open 	<ol style="list-style-type: none"> Check intake pipe is airtight. Make sure filter is immersed by at least 10 cm. Pump need to be primed again. Remove the NRV. Clean it, remove the clogged particles and fit it accordingly.
<ul style="list-style-type: none"> Pump runs continuously 	<ol style="list-style-type: none"> SENSORERROR - Sensor Paddle is closed SW ERROR (Reset Switch error) - Bell push Switch is short as water goes inside the switch. 	<ol style="list-style-type: none"> Remove the sensor and clean it by clean water and fit it again correctly. Note : Position of the sensor must remain unchanged. Just open the switch. Make it dry and fit it again properly. Note : Take the precautions so that water should not go inside switch.
<ul style="list-style-type: none"> Flow rate decreased 	<ol style="list-style-type: none"> Filter clogged Small amount of air is sucked with water. 	<ol style="list-style-type: none"> Clean the filter Tighten or change the suction pipe as air is sucked.
<ul style="list-style-type: none"> Water quantity varies against the set quantity. 	<ol style="list-style-type: none"> Small amount of air is sucked with water. Changes made in software settings by unknown person. 	<ol style="list-style-type: none"> Tighten or change the suction pipe as air is sucked. Refer the user manual to correct the software.

NOTES : 1. For trouble free results, use sealed plastic drum for the water storage.

PANERA AUTOMATIC LIQUID DISPENSER

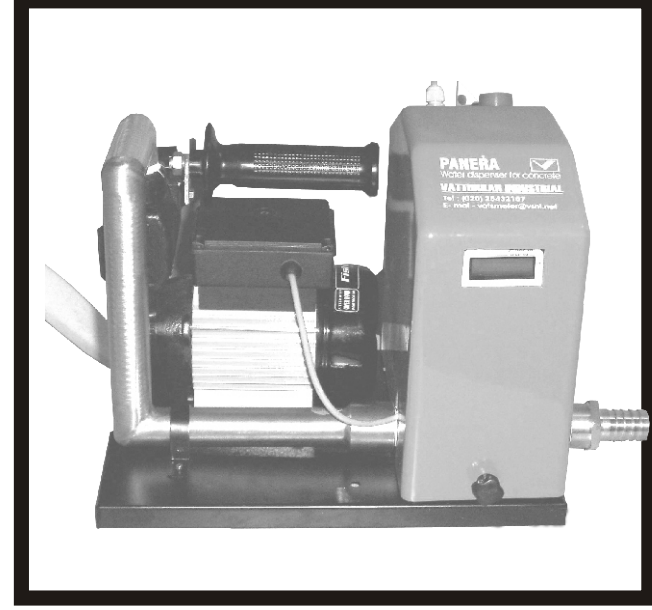

USER MANUAL



VATTURKAR INDUSTRIAL

B-14/3, Bandhan Society, Kothrud, Pune - 411 029
Tel : 020-25430897 / 25432157 / 25436180 / 56241462
E-mail - vatsmeter@vsnl.net

CALIBRATION PAGE: -

1. To Set Batch: -

Press  key, the unit will display.

SETBATCH

Then by using  &  keys.

Set the batch & then press  keys.

2. Calibration of the Instruments at site : -

Most important component of the machine is digital flow meter. To calibrate the machine, we suggest you to use

Physical Volumetric Calibration Method:

Example -1,

if the batch set is of 10 liters and you get the water is 9 liters at Output.

Corrective Action suggested: It shows that error is of -10%. In this case we suggest you to decrease the scale factor by 10% from existing Scale factor as error is of 10%.

Example - 2

If the batch is 10 liters and you get 11liters at output

Corrective Action Suggested: It shows that the error is of +10%. In this case we suggest you to increase the scale factor by 10% to existing Scale factor as Error is of 10%.



Note: Please change the SCALE FACTOR exactly i.e. the same percentage of the +/- error observed in Physical Calibration.

2A) Steps to go for 'scale factor' using front keys and password:

For setting scale factor: -

Press  key for 5 seconds or until unit will display,
PASSWORD

000000

Then Press  &  keys to set the display as 000031

Then Press  key, the unit display scale factor,

SETSCALE

0-----

Press  &  keys to increase or decrease scale factor.

Press  key, the unit will display

EXPONENT

10 e+0

Press  key, the unit will display

VATS

PANERA

000000.0

Then start the batch and check the output quantity of water.

CALIBRATION CERTIFICATE

Vatturkar Industrial
B 14/3 Bandhan Society
Kothrud, Pune -29
E-mail : vatsmeter@vsnl.net

TEST REPORT

	Standard	Setting
Product :		
Capacity :		
Model :		
S. No : .		
Size :		

This is to certify that the products mentioned above have been tested and calibrated at our works and have been found working satisfactorily as per technical specifications of the product.

WARRANTEE CERTIFICATE

We certify that the instrument mentioned above has been tested by us and is warrantee for a period of 12 months from the date of dispatch.

We undertake to make good by replacement or repair defects arising due to Faulty design, material or workmanship within the above mentioned period. Provided that the part in respect to which the complaint is made, is sent at the purchaser's expense.

The warrantee is valid subject to:

The meter or part there of not being subjecty to alteration, accident abuse or misuse

The installation having been done as per guide lines in the manual.

Client :

Date of dispatch : for Vatturkar Industrial

Authorised Signatory

Routine Maintenance

SUCTION FILTER

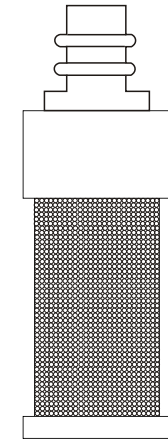

It is very essential to use as it protects the pump & flow sensor from any foreign particles.

MAINTENANCE :

Clean the filter daily after completion of concreting.

PROCEDURE :

- Remove the filter from suction pipe.
- Clean it by wire brush so that it should not choke up.

FLOW SENSOR

FLOW SENSOR
ORANGE CAP

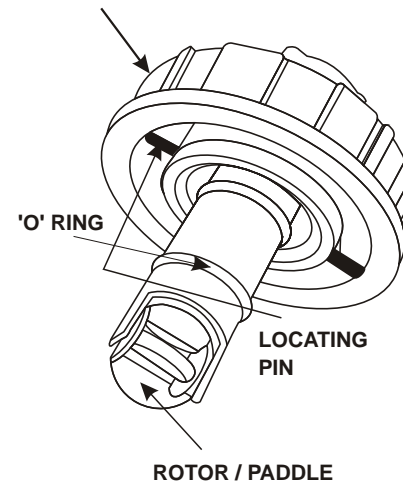

It measures the quantity of water flowing through Pump.

MAINTENANCE :

Clean the Flow Sensor at least once a week.

PROCEDURE :

- Remove the sensor cap (orange colour)
- Check the Rotor / Paddle for any deposition of particles on it.
- Clean it using clean cloth
- Fix it as the locating pin should fit in the provided notch on 'T' fitting.